



Artificial Intelligence Computing Platform

28F1E4

Datasheet



Version V1.0

Date 2025-11-20

Copyright by Beijing Plink-AI Technology Co., LTD.2023.All rights reserved.

No part of this document may be reproduced or transmitted in any form or by any means without prior written consent of Plink-AI Technologies Co., Ltd.

Notice

The purchased products, services and features are stipulated by the contract made between Plink-AI and the customer. All or part of the products, services and features described in this document may not be within the purchase scope or the usage scope. Unless otherwise specified in the contract, all statements, information, and recommendations in this document are provided "AS IS" without warranties, guarantees or representations of any kind, either express or implied.

The information in this document is subject to change without notice. Every effort has been made in the preparation of this document to ensure accuracy of the contents, but all statements, information, and recommendations in this document do not constitute a warranty of any kind, express or implied.

Please scan code for more products



Website



WeChat Channel



Video Account

Beijing Plink-AI Technology Co., LTD

Web: <http://www.plink-ai.com/>

Add: Jinyu Jiahua Building, Shangdi 3rd Street, Haidian District, Beijing

Tel: +86-010-62962285/400-127-3302

28F1E4 Product Manual Revision History

Version	Date	Description of Change	Hardware Version
V 1.0	2025-11-20	Create a document	V 1.0

Product Hardware Revision History

Version	Date	Description of Change
V 1	2025-11-20	Initial version

Electronic components and circuits are very sensitive to electrostatic discharge, although the company will design the main interface on the board card to do anti-static protection design, but it is difficult to do anti-static safety protection for all components and circuits. Therefore, it is recommended that you take ESD safety measures when handling any circuit board component.

ESD safety measures include but are not limited to the following:



1. Put the card in an ESD bag during transportation or storage. Do not take out the card until installation and deployment.
2. Before touching the board, release the static electricity stored in the body: Wear a grounding wrist strap.
3. Operate circuit boards only in electrostatic discharge safe areas.
4. Avoid moving circuit boards in carpeted areas.
5. Avoid direct contact with electronic components on the board through edge contact.

Table of Contents

1 Product Introduction	5
2 Basic parameters and IO interfaces	6
3 External interfaces and functions	7
4 Dimension drawing	10
5 28F1E4 Interface description	11
6 Order Information	16
7 Recovery Mode	16
8 Method of Application	17
9 CAN Test	17
10 RS232 Test	18
11 RS485 Test	19
12 Special Instructions	20

Product Introduction



The 28F1E4 artificial intelligence computing platform (hereinafter referred to as 28F1E4) can be compatible with the NVIDIA Jetson AGX Thor T5000 core module. It can provide a maximum computing power of 2070 TFLOPS and has a rich set of external interfaces. The internal interface components all adopt wide-temperature models.

In terms of interface configuration, 28F1E4 provides 4 USB 3.0 Type-A and 2 USB Type-C interfaces, which provide sufficient high-speed data channels for connecting multiple high-definition industrial cameras and external devices; 4 gigabit RJ45 network ports support complex network topologies and device networking. For industrial sites, 28F1E4 integrates 2 RS232, 2 RS485 and 4 CAN buses, which can seamlessly connect with mainstream industrial equipment such as PLC, servo drives and sensors.

To ensure signal integrity in complex electromagnetic environments, the device also has built-in 4 isolated GPI and 4 isolated GPO (with adjustable 3.3V/5V), as well as 3 isolated UARTs, effectively enhancing the system's anti-interference ability and reliability. At the same time, a built-in SIM card slot supports 4G/5G wireless communication, giving the device flexible remote access capabilities. The integrated stereo microphone input and headphone output interfaces provide complete audio hardware support for voice recognition and interaction applications.

Basic parameters and IO interfaces

Basic parameters	
Carrier Board	Y-C28
Adaptive Module	NVIDIA Jetson AGX Thor module
Temperature	-20~65°C
Dimensions (LxWxH)	187mm*180mm*75mm (Not including I/O ports and mounting holes)
Weight	1763g
Power Input	DC 9~36V

Interface	Quantity	Interface	Quantity
USB 3.0 Type-A	4	USB 3.2 Type C	2
RJ45	4	USB Type-C(OTG)	1
RS232	2	RS485	2
CAN	4	Nano SIM Card Slot (interiorly)	1
Isolation GPI (3.3V/5V)	4	Isolation GPO (3.3V/5V)	4
Isolation UART(3.3V)	3	Stereo microphone	2
Stereo headphone	2	HDMI	1

External interfaces and functions



28F1E4 Front interface indication diagram

Sign	Function	Sign	Function
FP	Only for system burning	HDMI	Type-A HDMI connector
LAN1	Gigabit network port RJ45	LAN2	Gigabit network port RJ45
REC	Recovery Key	RST	Reset Key
PWR	Power Key	P	Power supply indicator light
S	User-defined indicator light	R	Module power-on indicator light
USB connector	Double-layer Type C USB 3.2 & 4 Type A USB 3.0 connectors		

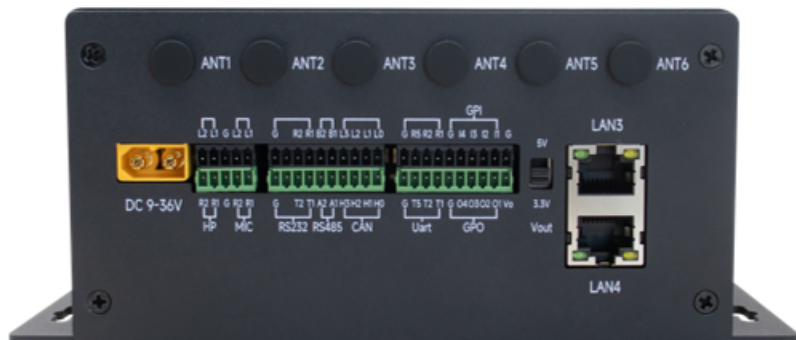

28F1E4 Backside interface indication diagram

Sign	Function	Sign	Function
DC 9~36V	Power input	HP	Stereo headphone
MIC	Stereo microphone	RS232	RS232 level standard interface
RS485	RS485 level standard interface	CAN	CAN bus
Uart	Isolated serial port (standard TTL level)	GPI	Isolate GPIO input (adjustable voltage) Only Input
GPO	Isolate the GPIO output (adjustable voltage) Only output	Vout	Adjustable to either 3.3V or 5V voltage
LAN3	Gigabit network port RJ45	LAN4	Gigabit network port RJ45
ANT1~4	5G Antenna hole	ANT5~6	wifi Antenna hole

Adaptation Jetson AGX Thor T5000

Module parameters

Module	Jetson AGX Thor T5000
AI Performance	2070 TFLOPS (FP4—sparse)
GPU	2560-core NVIDIA Blackwell architecture GPU with 96 fifth-gen Tensor Cores Multi-Instance GPU with 10 TPCs
GPU Max Frequency	1.57 GHz
CPU	14-core Arm® Neoverse®-V3AE 64-bit CPU 64 KB I-Cache, 64 KB D-Cache 1 MB L2 cache per core 16 MB shared system L3 cache
CPU Max Frequency	2.6 GHz
Memory	128 GB 256-bit LPDDR5X 273 GB/s
Storage	Supports NVMe through PCIe Supports SSD through USB3.2
Video Encode	6x 4Kp60 (H.265) 12x 4Kp30 (H.265) 24x 1080p60 (H.265) 50x 1080p30 (H.265) 48x 1080p30 (H.264) 6x 4Kp60 (H.264)
Video Decode	4x 8Kp30 (H.265) 10x 4Kp60 (H.265) 22x 4Kp30 (H.265) 46x 1080p60 (H.265) 92x 1080p30 (H.265) 82x 1080p30 (H.264) 4x 4Kp60 (H.264)
Power	40 W-130 W

Dimension drawing (mm)

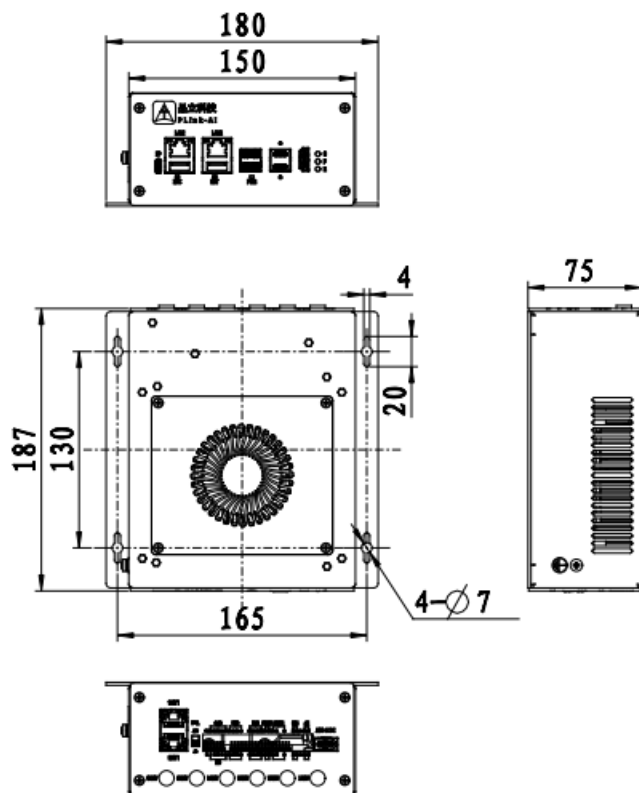

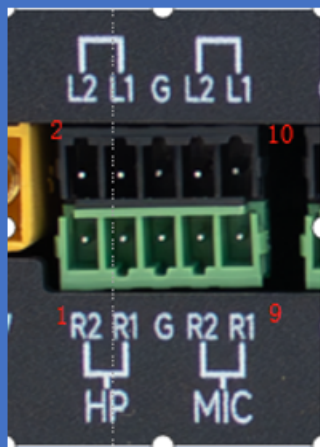

Audio	pin	Screen-printed logo	Function definition	pin	Screen-printed logo	Function definition
	1	R2	HeadPhone_R_channel_2	2	L2	HeadPhone_L_channel_2
	3	R1	HeadPhone_R_channel_1	4	L1	HeadPhone_L_channel_1
	5	G	Digital GND	6	G	Digital GND
	7	R2	Microphone_R_channel_2	8	L2	Microphone_L_channel_2
	9	R1	Microphone_R_channel_1	10	L1	Microphone_L_channel_1

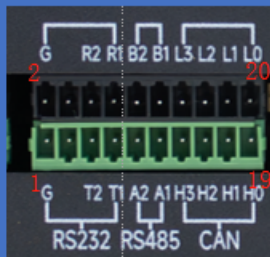

	pin	Screen-printed logo	Function definition	pin	Screen-printed logo	Function definition
RS232	1	G	Digital GND	2	G	Digital GND
	3		Debug serial port_TX	4		Debug serial port_RX
	5	T2	RS232_TX2	6	R2	RS232_RX2
	7	T1	RS232_TX1	8	R1	RS232_RX1

explain
 Device number:
 RS232_1:/dev/ttyWCH0
 RS232_2:/dev/ttyWCH1
 The middle reserved part is the kernel debugging serial port, which is used to output C-BOOT, U-BOOT and Linux kernel information. After the Linux kernel starts, it is used as the display control terminal serial port. The default serial port settings are: 115200, 8N1. (This serial port operates at TTL level.)

	pin	Screen-printed logo	Function definition	pin	Screen-printed logo	Function definition
RS485	9	A2	RS485_A2	10	B2	RS485_B2
	11	A1	RS485_A1	12	B1	RS485_B1

explain
 Device number:
 RS485_1:/dev/ttyWCH2
 RS485_2:/dev/ttyWCH3
 Support the maximum rate: 16Mbps

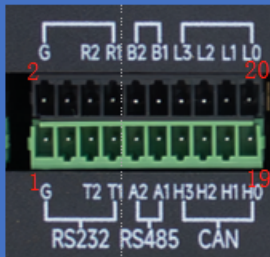

	pin	Screen-printed logo	Function definition	pin	Screen-printed logo	Function definition
CAN	13	H3	CAN3_H	14	L3	CAN3_L
	15	H2	CAN2_H	16	L2	CAN2_L
	17	H1	CAN1_H	18	L1	CAN1_L
	19	H0	CAN0_H	20	L0	CAN0_L
explain	Device number: CAN3_H/L : CAN3 CAN2_H/L : CAN2 CAN1_H/L : CAN1 CAN0_H/L : CAN0					

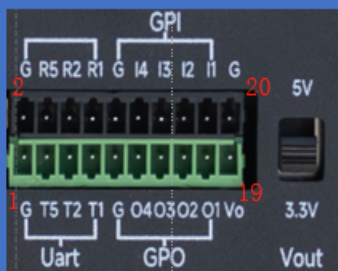

Isolation UART	pin	Screen-printed logo	Function definition	pin	Screen-printed logo	Function definition
	1	G	Digital GND	2	G	Digital GND
	3	T5	UART5_TX	4	R5	UART5_RX
	5	T2	UART2_TX	6	R2	UART2_RX
	7	T1	UART1_TX	8	R1	UART1_RX

explain

This UART is an electrically isolated UART module.

Device number:
 UART1 : /dev/ttyAMA9
 UART2 : /dev/ttyAMA10
 UART5 : /dev/ttyAMA5

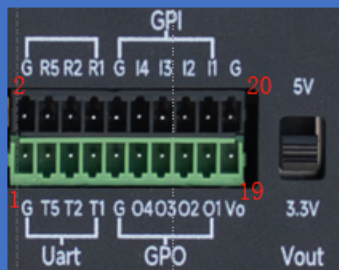

	pin	Screen-printed logo	Function definition	pin	Screen-printed logo	Function definition
Isolation GPIO	9	G	Digital GND	10	G	Digital GND
	11	O4	GPO4	12	I4	GPI4
	13	O3	GPO3	14	I3	GPI3
	15	O2	GPO2	16	I2	GPI2
	17	O1	GPO1	18	I1	GPI1
	19	Vo	Output voltage	20	G	Digital GND

explain

This group of GPIOs are electrically isolated GPIOs.
 GPI can only be used for input, while GPO can only be used for output.

Note:
 When Vout is set to the 5V marking: The Vout output voltage is 5V@1A
 GPO and GPI have a high level of 5V
 When Vout is set to the 3.3V silk-screened position: The Vout output voltage is 3.3V@1A
 The GPO and GPI high levels are 3.3V

Note:
Do not perform any operation with Vout powered on.
Before use, make sure that the external input level is consistent with the selected level of Vout to prevent damage to the equipment.

Ordering Information

Order Type	Function
28F1E4	An artificial intelligence computing platform that is compatible with the core modules of NVIDIA® Jetson™ AGX Thor series
If you need to add other functional modules, please contact our sales or technical staff in advance to discuss the solution.	

Recovery Mode

The Jetson core module can operate in normal mode and Recovery mode. In Recovery mode, operations such as file system update, kernel update, Bootloader/UEFI update, BCT update, etc. can be performed.

The steps to enter Recovery mode are as follows:

Turn off the power supply of the system.

Connect the Type-C cable to the Type-C port (FP) of 28F1E4 and the USB port of the Jetson development host.

The Jetson development host should be an X86 architecture system running Ubuntu 22.04.

Press and hold the Recovery button (REC) without releasing it. Supply power to the system. After power supply, keep the Recovery (REC) button pressed for more than 3 seconds, then release the Recovery button (REC).

The system enters the Recovery mode. At this point, you can perform subsequent operations.

Method of Application

- Make sure that the voltages of all external systems have been turned off.
- Install the necessary external cables. (For example: the display cable connected to the HDMI monitor, the power input cable for powering the system, the USB cable linking the keyboard and mouse...) Connect the power cable to the power source.
- 28F1E4 is set by default to automatically power on the system.

CAN Test

- The 28F1E4 complete machine is equipped with 4 CAN signals by default. It can be used to test two CAN signals by connecting them together, or it can be used to test by connecting to external devices. During the test, please connect the CAN_H of the device to the CAN_H of the device under test, and CAN_L to CAN_L of the device under test. The test commands are as follows:

```
sudo apt-get install busybox can-utils
```

```
$sudo busybox devmem 0x8110310000 w 0xc458  
$sudo busybox devmem 0x8110310020 w 0xc400  
$sudo modprobe can  
$sudo modprobe can_raw  
$sudo modprobe mttcan  
$sudo ip link set can0 type can bitrate 500000 loopback on  
$sudo ip link set up can0  
$candump can0  
$cansend can0 123#11223344aabbccdd
```

Please refer to the link for the values of the module registers:

[Controller Area Network \(CAN\) — Jetson Linux Developer Guide documentation \(nvidia.com\)](#)

RS232 Serial Port Test

The 28F1E4 model is equipped with two RS232 serial ports as standard. It can perform self-reception and self-transmission tests for a single serial port, as well as conduct connection tests by connecting two RS232 serial ports together. The commands are as follows:

- `sudo apt-get install cutecom` #Install the serial port testing tool
- `sudo cutecom` #When conducting a single serial port test, only one terminal needs to be opened. For the two-channel serial port connection test, please use two terminals respectively and open two cutecom interfaces.
- When conducting a single serial port test, connect the RX of the single serial port to its TX; when testing the connection of two serial ports, connect the RX of RS232_0 to the TX of RS232_1, and the TX of RS232_0 to the RX of RS232_1.
- During the test, set the serial port parameters in the cutecom interface and open the serial port. After entering and outputting the data in the input box and sending it, the single serial port test will have data echo displayed at the bottom of the cutecom interface. In the two-way serial port connection test, both serial ports need to be opened simultaneously using cutecom. When RS232_1 sends data, the data will be echoed at the bottom of the interface of RS232_0. The interface of the serial port testing tool cutecom is as follows:

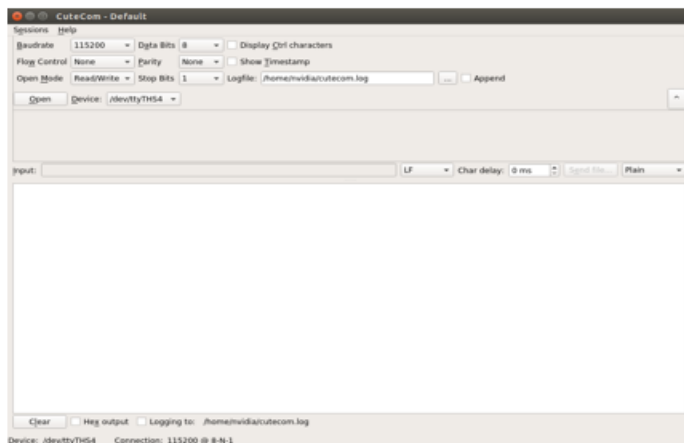

RS485 Test

The 28F1E4 model is equipped with two RS485 serial ports by default. These two RS485 ports can be connected to each other for testing.

Since RS485 requires configuration when in use, the testing can only be conducted using the sample program.

The download address of the sample program: <https://gitee.com/plink718/11f1e2-io-test>

The sample program can also be used for testing RS232 serial ports. Please refer to the README in the above link for the usage instructions.

GPIO Test

The 28F1E4 model is equipped with 4 isolated electrical GPIs and 4 isolated electrical GPOs.

The following sample program can be used for testing.

Sample program download address: <https://gitee.com/plink718/11f1e2-io-test>

Special instructions

- Initial system username: nvidia, password: nvidia. No su password has been set. To obtain root privileges, you can use sudo for privilege escalation, or use sudo su to enter the root user.
- The pre-installed system is a clean one and does not contain the Jetpack software. You can install it using the following commands. Before installation, please do not replace or modify the default software sources: sudo apt-get update
- sudo apt-get install nvidia-jetpack
- You can also use the SDKmanager software to install it via the network.
- For more information, please refer to: Jetson wiki (plink-ai.com)